

HIWIN® MIKROSYSTEM

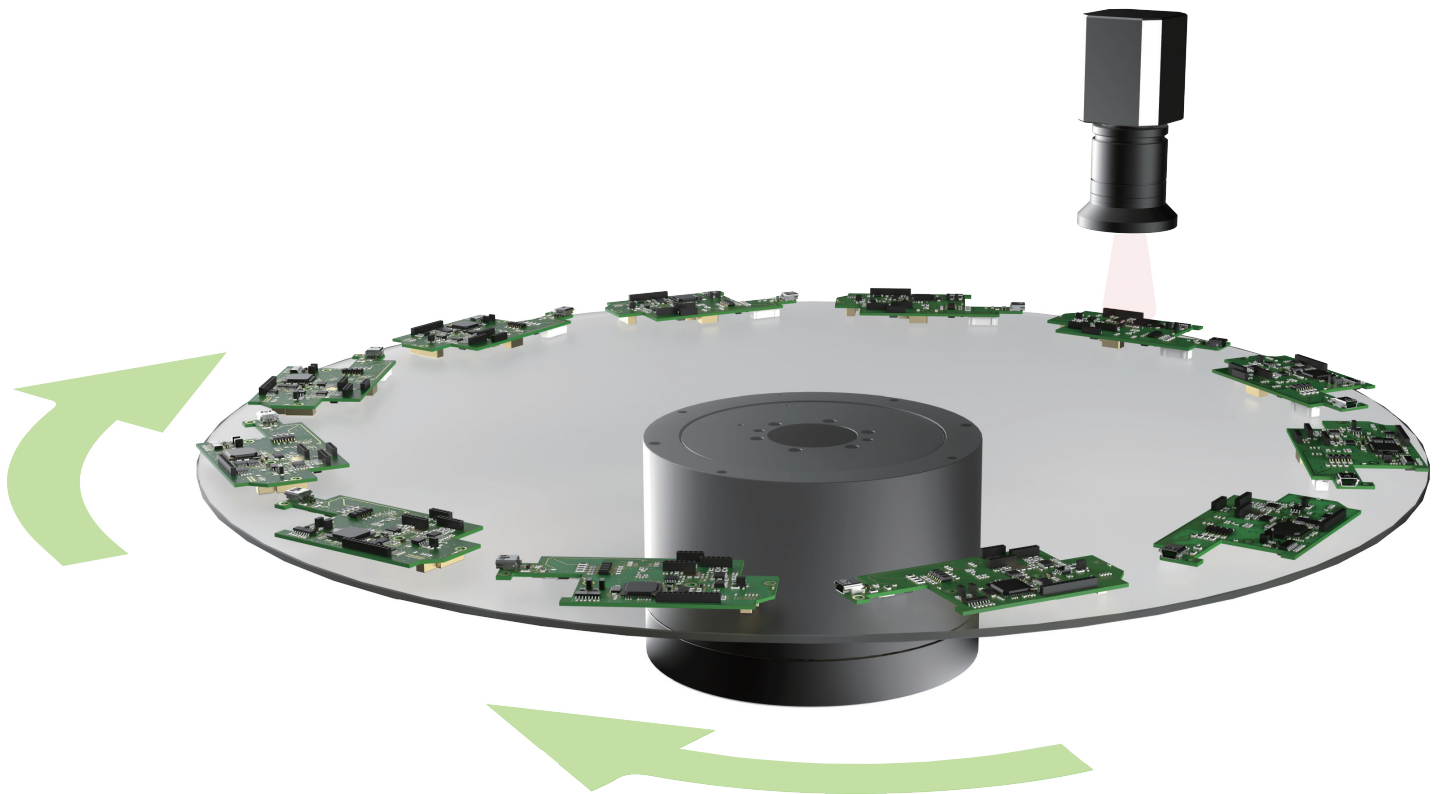

E Series Servo Drive

Multi-Motion Function
User Manual

Revision History

The version of the manual is also indicated on the bottom of the front cover.

MD32UE01-2308_V1.1

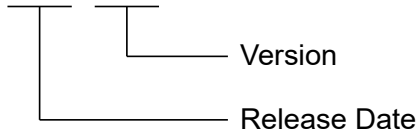

Release Date	Version	Applicable Product	Revision Contents
Aug. 14 th , 2023	1.1	E1 series servo drive E2 series servo drive	<ol style="list-style-type: none">1. Update chapter 1 Environment configuration.2. Update chapter 2 Preparation.3. Update section 3.6 Instructions for customized motion.4. Update section 3.8 Advanced setting.5. Update chapter 6 Related warning and alarm.6. Update section 7.1 Release note for multi-motion function.
Apr. 25 th , 2023	1.0	E1 series servo drive E2 series servo drive	First edition.

Related Documents

Through related documents, users can quickly understand the positioning of this manual and the correlation between manuals and products. Go to HIWIN MIKROSYSTEM's official website → Download → Manual Overview for details (https://www.hiwinmikro.tw/Downloads/ManualOverview_EN.htm).

Preface

Multi-motion applications, such as food filling and food sorting, can be achieved by multi-motion function. With a few input signals, multi-motion movement can be completed. Thunder's "Multi-motion setting" window allows users to set basic parameters, such as motion number, input pin and type to complete the motion script and then check its correctness via simulation window. By doing so, the ideal of rapidly importing multi-motion applications can be achieved.



Motion#	Type of motion	Position (deg)	Velocity (deg/s)	Direction	Number of station
Motion#1	Absolute move	360	3,600	Shortest path	--
Motion#2	Absolute move	360	3,600	Positive	--
Motion#3	Absolute move	90	3,600	Negative	--
Motion#4	Relative move	90	3,600	Positive	--
Motion#5	Relative move	90	3,600	Negative	--
Motion#6	JOG	--	3,600	Positive	--
Motion#7	JOG	--	3,600	Negative	--
Motion#8	Homing Operation	--	--	--	--
Motion#9	Indexing movement-1	--	3,600	Positive	6
Motion#10	Indexing movement-1	--	3,600	Negative	6
Motion#11	Indexing movement-2	--	3,600	Positive	6
Motion#12	Indexing movement-2	--	3,600	Negative	6
Motion#13	Software enable	--	--	--	--
Motion#14	Software disable	--	--	--	--
Motion#15	Clear error	--	--	--	--
Motion#16	Zero Point Position Offset	--	--	--	--

Table of Contents

1.	Environment configuration	1-1
2.	Preparation.....	2-1
3.	Setting procedure.....	3-1
3.1	Add motion.....	3-3
3.2	Set motion.....	3-5
3.3	Type of motion	3-7
3.4	Activate multi-motion function.....	3-9
3.5	Disable multi-motion function	3-11
3.6	Instructions for customized motion	3-12
3.7	Application setting: infinite rotation function	3-15
3.8	Advanced setting	3-16
4.	Save/Load multi-motion parameters file	4-1
4.1	Read multi-motion parameters from servo drive	4-2
4.2	Save/Load multi-motion parameters file (*.mtk)	4-2
5.	Test run.....	5-1
5.1	Test run for multi-motion	5-2
5.2	Monitor load position.....	5-5
6.	Related warning and alarm	6-1
7.	Appendix	7-1
7.1	Release note for multi-motion function	7-2
7.2	Old version's related warning	7-5

(This page is intentionally left blank.)

1. Environment configuration

1. Environment configuration	1-1
------------------------------------	-----

When using multi-motion function, it is recommended to use standard servo drive (model: ED1S-V□, ED2S-V□) and Thunder version 1.9.18.0 or above. Applicable motor types and descriptions are shown in the following table. Refer to section 7.1 for the release note.

Table 1.1 Supported motor types

Motor Type	Description
Direct drive motor (DM) Torque motor (TM)	Applicable to direct drive
Linear motor (LM)	Applicable to direct drive
AC servo motor (AC)	Applicable to the reducer with reduction ratio of 1:5000 or below

2. Preparation

2. Preparation.....	2-1
---------------------	-----

⚠ CAUTION

- ◆ When multi-motion function is used, PDL can only support 1 task. Before using multi-motion function, ensure PDL does not exceed 1 task. Refer to section 9.5 **PDL** in “E Series Servo Drive Thunder Software Operation Manual” for details.
- ◆ The usage of encoder will affect the behavior of multi-motion function. Before using multi-motion function, set Pt002.□X□□ according to the encoder type (multi-turn, single-turn absolute or increment). Refer to section 6.12.3 **Parameter settings for encoder** in “E1 Series Servo Drive User Manual” and section 6.12.3 **Parameter settings for encoder** in “E2 Series Servo Drive User Manual” for details.

Before using multi-motion function, follow the steps below to complete preparation.

Step 1: Select internal position mode as control mode

Multi-motion function is only applicable to internal position mode. Therefore, set control mode as Pt000.□□A□.

Step 2: Set “Electronic gear ratio setting” window

Refer to section 4.3.6.3 **Electronic gear ratio setting** in “E Series Servo Drive Thunder Software Operation Manual”. Go to “Electronic gear ratio setting” window  in Thunder’s Configuration Wizard to complete the setting, as Figure 2.1 shows.

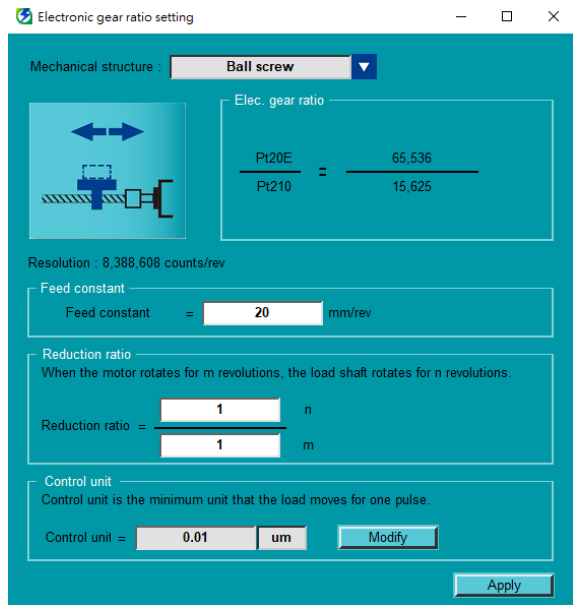

Figure 2.1 “Electronic gear ratio setting” window



Important

- (1) When rotary motor is used, if mechanical structure is not selected or is selected as **Other**, it will be viewed as a rotary mechanism with reduction ratio of 1:1.
- (2) When dual-loop structure is used, mechanical structure cannot be changed.

Step 3: Disable the function of input pins

Refer to section 4.5 I/O configuration in “E Series Servo Drive Thunder Software Operation Manual”. Go to “I/O configuration” window and set all the input pins for multi-motion function as **Not configure**, as Figure 2.2 shows.

Table 2.1 Number of input pins corresponding to motion number

Motion number	Number of input pins to be set
1	2
2 ~ 3	3
4 ~ 7	4
8 ~ 15	5
16 ~ 31	6
32 ~ 63	7
64 ~ 127	8
128 ~ 255	9

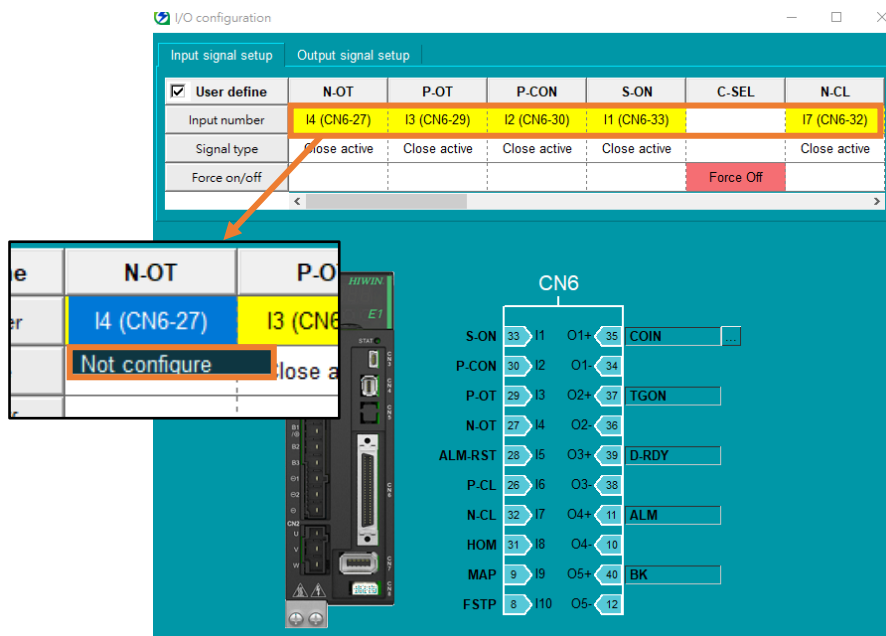

Figure 2.2 “I/O configuration” window



Important

- (1) Save an input pin for S-ON or configure a “Software enable” motion (refer to section 3.3).
- (2) Do not set P-OT and N-OT as **Not configure** when using overtravel function.

3. Setting procedure

3.	Setting procedure	3-1
3.1	Add motion.....	3-3
3.2	Set motion.....	3-5
3.3	Type of motion	3-7
3.4	Activate multi-motion function.....	3-9
3.5	Disable multi-motion function	3-11
3.6	Instructions for customized motion	3-12
3.7	Application setting: infinite rotation function	3-15
3.8	Advanced setting	3-16

After completing preparation, click “Open multi-motion setting” icon  in Thunder’s toolbar.

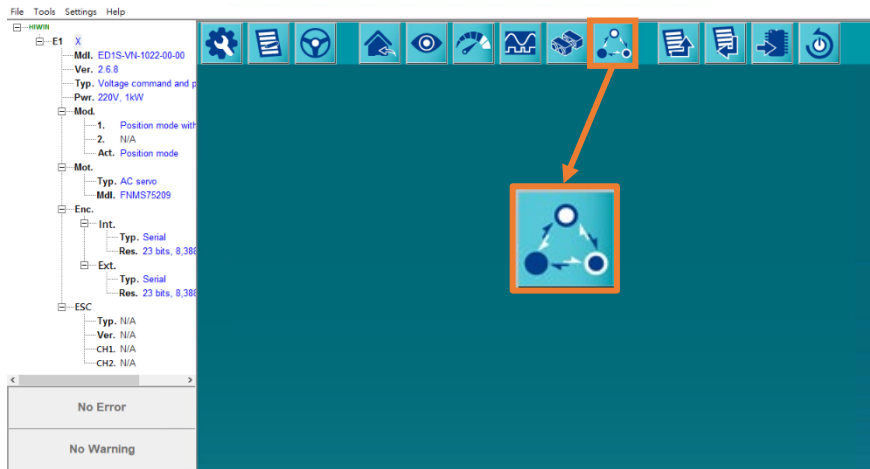

Figure 3.1 Open “Multi-motion setting” window



Important

If users have already set electronic gear ratio based on the previous chapter, refer to section 10.2 **Display unit switching** in “E Series Servo Drive Thunder Software Operation Manual” to convert display unit to load side’s unit for follow-up setting.

The steps to set multi-motion parameters and activate multi-motion function are given as follows.

- Step 1:** Add motion, refer to section 3.1.
- Step 2:** Set motion, refer to section 3.2.
- Step 3:** Activate multi-motion function, refer to section 3.4.

3.1 Add motion

1. Click “New or Modify” icon  to open “Set motion number and specify input signal” window. After users key in “Motion number”, the signal configuration corresponding to each motion will be automatically generated.

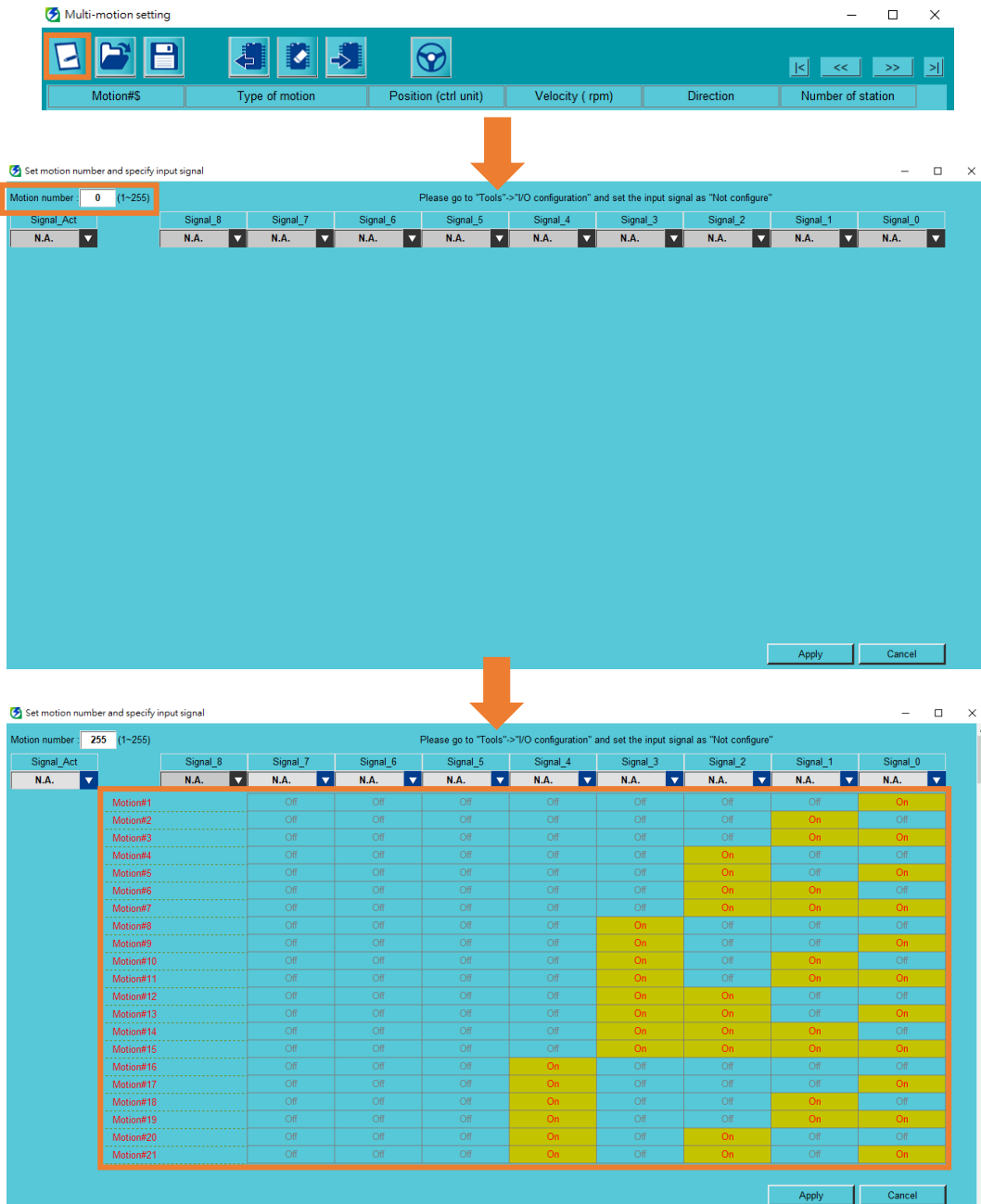

Figure 3.1.1 Set motion number

2. Set input pins of “Signal_Act” and “Signal_0~8”.

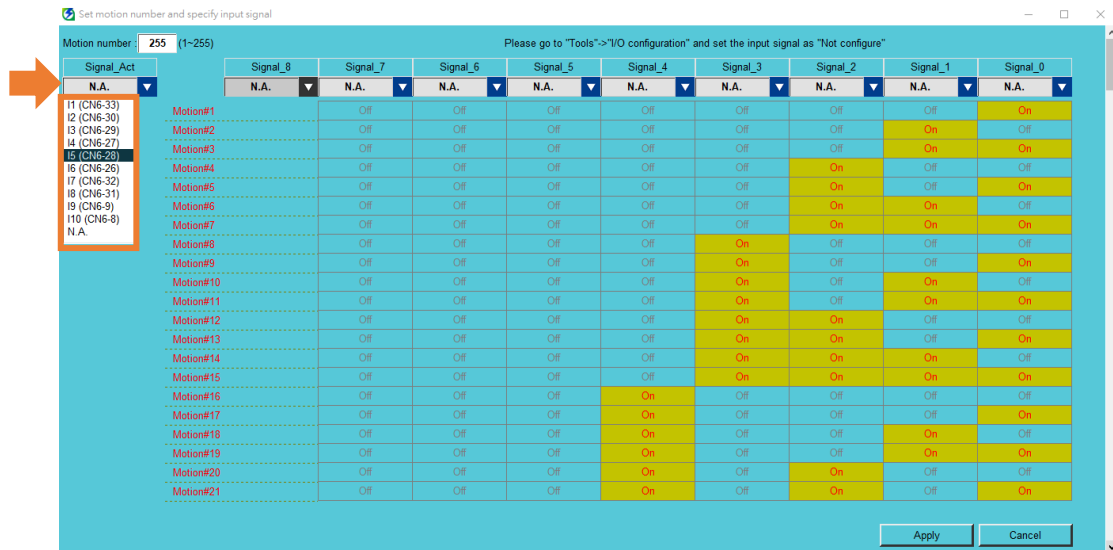

Figure 3.1.2 Allocate the pins of signal



Important

- (1) Users must configure Signal_Act signal as the switch to activate/stop the motion. If Signal_Act signal is triggered, servo drive will activate the designated motion. If Signal_Act signal is disabled, the specific motion (e.g., JOG) will be stopped.
- (2) After deciding the motion to be activated, keep the status of Signal_Act signal as disabled. After triggering the corresponding signal of Signal_0~8, trigger Signal_Act signal.



Example

Motion#1 is the combination of I2 and I5, and I5 is Signal_Act signal. To activate Motion#1, host controller must trigger I2 first and then trigger I5. To activate Motion#1 again, host controller must change the level of I5 first before triggering I2 and I5.

	Signal_Act I5	Signal_1 I3	Signal_0 I2
Motion#1	On	Off	On
Motion#2	On	On	Off

3. After the setting is done, click **Apply**.

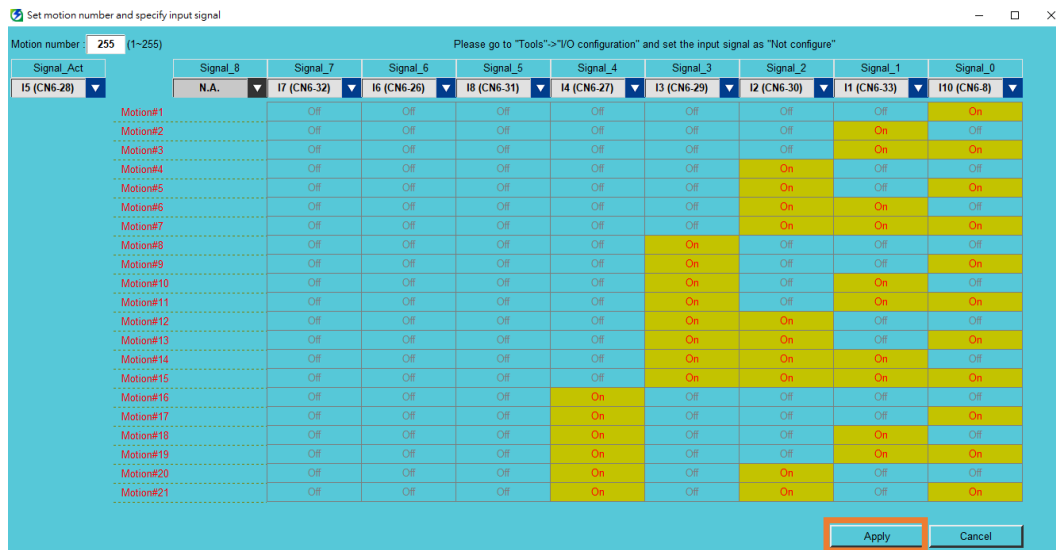

Figure 3.1.3 Apply the setting

- An information window will pop up. Click **OK** and check if there is a conflict in input signal configuration.

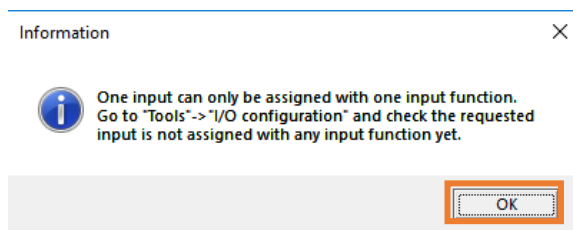

Figure 3.1.4 Check window

⚠ CAUTION

- ◆ If there is a conflict in input signal configuration, the function of other digital input may be falsely triggered when multi-motion function is used.

3.2 Set motion

- After the setting of section 3.1 is done, “Multi-motion setting” window will generate the corresponding motion number. The default of each motion is **N.A.**.



Figure 3.2.1 Default motion setting

2. Select type of motion (refer to section 3.3) and set the corresponding parameters.

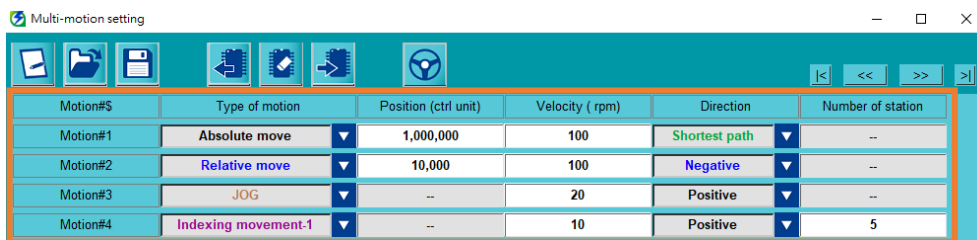

Figure 3.2.2 Motion setting

3. With display unit switching, the value and unit of multi-motion parameters will change according to the converted unit.

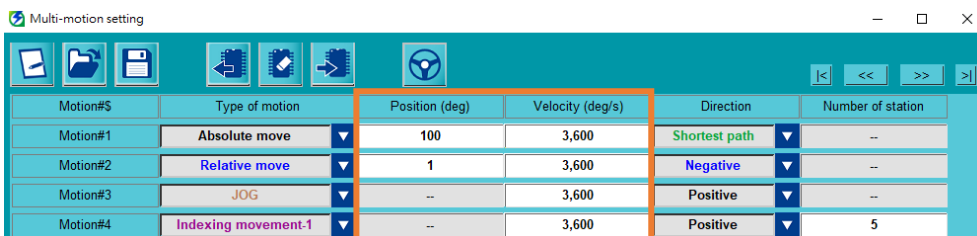

Figure 3.2.3 Unit conversion

3.3 Type of motion

Multi-motion function supports the following types of motion:

Table 3.3.1 Type of motion

Type of Motion	Applicable Mechanism	Description
Absolute move	Rotary / Linear	Move the motor to the position specified by users with the velocity and direction specified by users.
Relative move	Rotary / Linear	Move the motor for a distance specified by users with the velocity and direction specified by users.
Indexing movement	Rotary	<p>The position of each station will be automatically calculated by the number of station specified by users. After the command is triggered, the motor will move to the next station with the velocity and direction specified by users. Currently, there are two kinds of Indexing movement:</p> <p>Indexing movement-1</p> <p>If the motor is disabled and moved to other position during indexing movement, the first command after the motor is re-enabled will move the motor to the last target station.</p> <p>Indexing movement-2</p> <p>If the motor is disabled and moved to other position during indexing movement, the first command after the motor is re-enabled will move the motor to the next station closest to the current position.</p> <p>Take four stations and 90 degrees movement as the motion planning. When the servo drive receives the command and moves the motor from 0 degree to 90 degrees, the motor is disabled due to an error. During troubleshooting, the motor is accidentally moved to the range between 90 to 180 degrees. When the motor is re-enabled and the command is given:</p> <ul style="list-style-type: none"> ◆ Indexing movement-1 will remember the last target station, so it will go back to 90 degrees. ◆ Indexing movement-2 will move to 180 degrees, the next station for the current position.

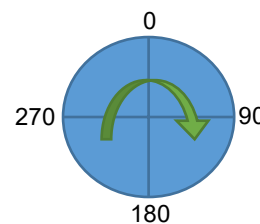

Type of Motion	Applicable Mechanism	Description
JOG	Rotary / Linear	Keep moving the motor with the velocity and direction specified by users.
Homing Operation	Rotary / Linear	Execute the homing method set by Pt700.
Customized motion	Rotary / Linear	The motor will do the movement based on the motion process edited by users in PDL (refer to section 3.6 for the example format).
Software enable	Rotary / Linear	Trigger software enable command of the servo drive.
Software disable	Rotary / Linear	Trigger software disable command of the servo drive.
Clear error	Rotary / Linear	Clear software error of the servo drive.
Zero Point Position Offset in Machine Coordinate System	Rotary / Linear	Set the current position of motor as new home position.



Important

- (1) JOG is “high level trigger”, so it will be activated or stopped based on high/low of Signal_Act signal. Others are “rising edge trigger”. After activated by triggering Signal_Act signal, the motion cannot be stopped by disabling Signal_Act signal during the execution. Users must wait until the motion is done.
- (2) With Pt662.□□□X, users can decide whether to use the current direction or the shortest path to make Indexing movement-1 back to the last target station.
- (3) When increment encoder is used, before executing the motion of Absolute move, Indexing movement and Zero Point Position Offset in Machine Coordinate System, the homing must be completed by multi-motion function. Other methods of triggering homing (e.g., Thunder’s “Homing Operation” window) are invalid.
- (4) Before executing the motion of Absolute move, Relative move, Indexing movement and JOG, the servo drive must be enabled.
- (5) When rotary mechanism is used, Absolute move only supports moving the motor to the position within one revolution (0~360 degrees). For example, the motor is currently at 0 degree, if users key in 760 degrees for Absolute move, the motor will only move to 40 degrees (760-360-360=40) instead of 760 degrees.

⚠ CAUTION

◆ When Zero Point Position Offset in Machine Coordinate System is executed, the value of Pt704 will be modified, the motor will be disabled, and the parameters will be sent to servo drive. If the motor is enabled before the execution, the servo drive will automatically re-enable the motor after the execution.

3.4 Activate multi-motion function

Follow the procedure below to save the set multi-motion parameters to servo drive and activate multi-motion function.

⚠ CAUTION

◆ When the motor is enabled, the parameters cannot be saved to servo drive.

1. Click “Send to drive” icon .

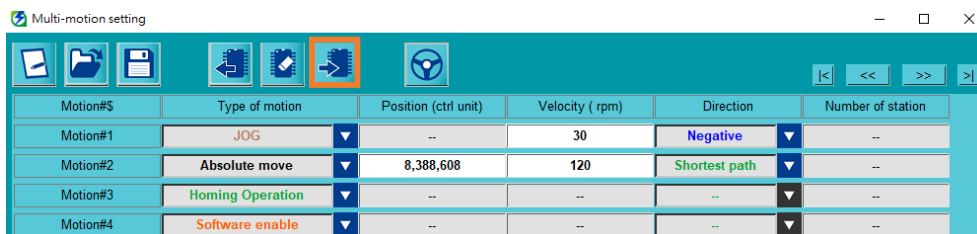

Figure 3.4.1 Save multi-motion parameters to servo drive

2. Read the check window and click **Yes**. At this time, the servo drive will automatically change the control mode to **Internal position mode**, and Fieldbus servo drive will automatically change the mastership to **MPI/API**.

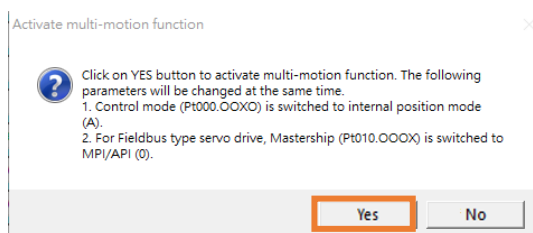

Figure 3.4.2 Check window of activating multi-motion function

- After the servo drive is power cycled, “Activate multi-motion function success!” window will pop up. After users click **OK**, the data will be successfully saved to servo drive. If there is no error or warning AL947 on the left side of Thunder main window, multi-motion function is successfully activated. If warning AL947 appears, check the cause and do troubleshooting (refer to chapter 6).

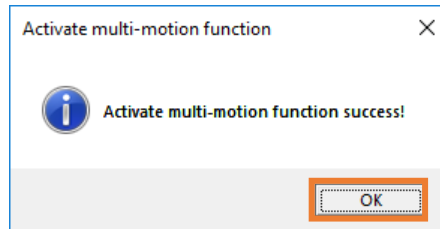

Figure 3.4.3 Message window of successfully activating multi-motion function

- After multi-motion function is activated, if warning AL947 does not appear, in the bottom-left corner of Thunder main window, the light of “Multi-motion activated” will light up.

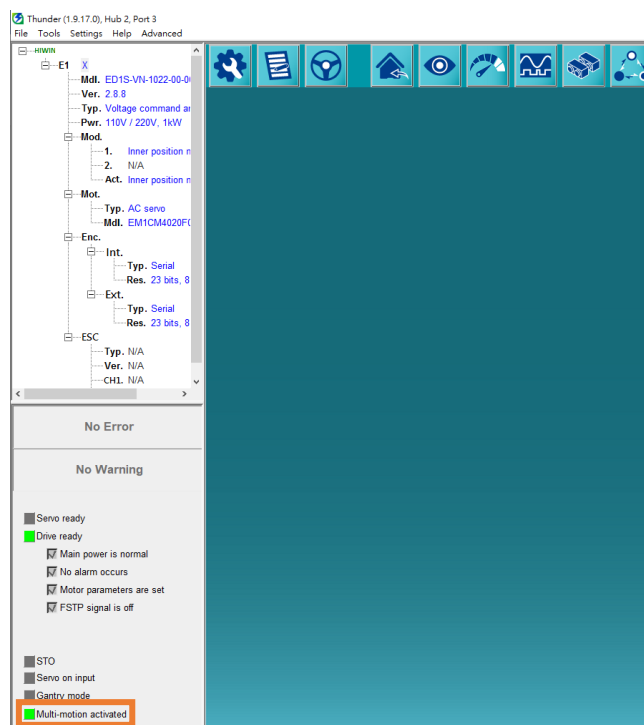

Figure 3.4.4 The light of “Multi-motion activated” lights up

CAUTION

- ◆ When AC servo motor is used with multi-turn absolute encoder (Pt002.□0□□), note the following points:
 - After successfully activating multi-motion function, refer to section 9.3 **Absolute encoder initialization** in “E Series Servo Drive Thunder Software Operation Manual” to execute absolute encoder initialization once via Thunder, save the parameters to servo drive and power cycle servo drive.

- II. If any of the following actions has been executed on customer's stage: change servo drive, change motor, change rotation direction of motor (Pt000.□□□X), before activating multi-motion function, execute absolute encoder initialization once, save the parameters to servo drive and power cycle servo drive.
- III. If the home position of load side has been positioned by homing method -3 (Pt700 = -3), after absolute encoder initialization is executed, the home position must be repositioned.

3.5 Disable multi-motion function

Follow the procedure below to clear the multi-motion parameters saved in servo drive and disable multi-motion function. To keep the setting of multi-motion parameters, refer to section 4.2 to save multi-motion parameters as multi-motion parameters file (*.mtk).

⚠ CAUTION

◆ Before disabling multi-motion function, ensure there is no code related to customized motion in PDL (refer to section 3.6).

1. Click "Clear data" icon .

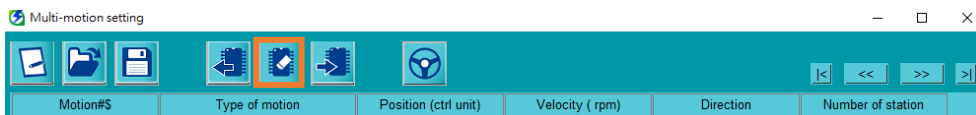

Figure 3.5.1 Clear multi-motion parameters

2. Read the check window and click **Yes**. At this time, the servo drive will be power cycled.

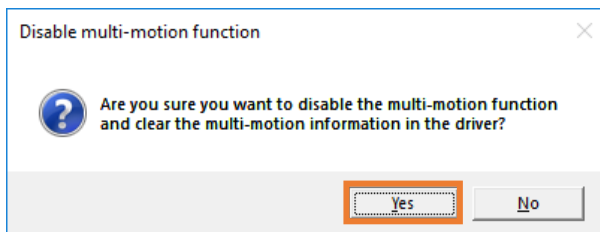

Figure 3.5.2 Check window of disabling multi-motion function

3. After the servo drive is power cycled, “Disable multi-motion function success!” window will pop up. After users click **OK**, the multi-motion parameters saved in servo drive will be successfully cleared and multi-motion function will be disabled.

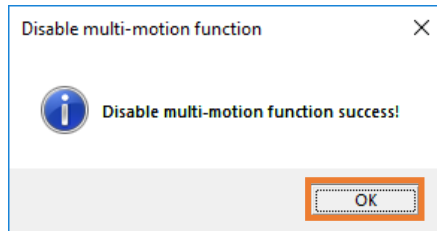

Figure 3.5.3 Message window of successfully disabling multi-motion function

4. After multi-motion function is disabled, in the bottom-left corner of Thunder main window, the light of “Multi-motion activated” will be gray.

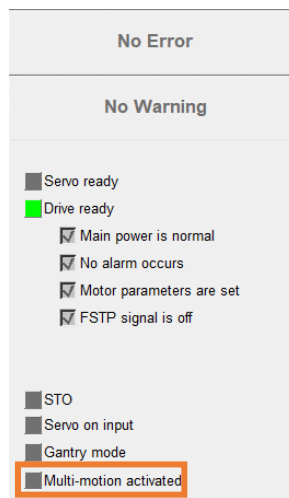

Figure 3.5.4 The light of “Multi-motion activated” is gray

3.6 Instructions for customized motion

Follow the procedure below to use customized motion.

1. Copy the example format below to PDL editing window.

```
/*The customized PDL sample for multi-motion function*/  
#define RUN 1  
#define END 2  
/*Each motion number should be the same as the multi-motion setting in Thunder.*/
```



```

#define motion1 1
#define motion2 2
#define motion3 3
#define motion4 4
/*-----main-----*/
#task/01;
MotionSample:
  till(CsMotion_Flag = RUN);
  if(MotionSel = motion1)do
    /*Motion process
     Do something*/
    CsMotion_Flag = END;
  end;
  if(MotionSel = motion2)do
    /*Motion process
     Do something*/
    CsMotion_Flag = END;
  end;
  if(MotionSel = motion3)do
    /*Motion process
     Do something*/
    CsMotion_Flag = END;
  end;
  if(MotionSel = motion4)do
    /*Motion process
     Do something*/
    CsMotion_Flag = END;
  end;
goto MotionSample;
ret;

```



(1) CsMotion_Flag is the flag to judge the motion status; 0 indicates no motion, 1 indicates in motion, and 2 indicates motion ends.

Information

(2) MotionSel is the motion number set in “Multi-motion setting” window.

2. Modify #define motion1 1 and so on in sequence to make them be the same as the motion number in “Multi-motion setting” window.

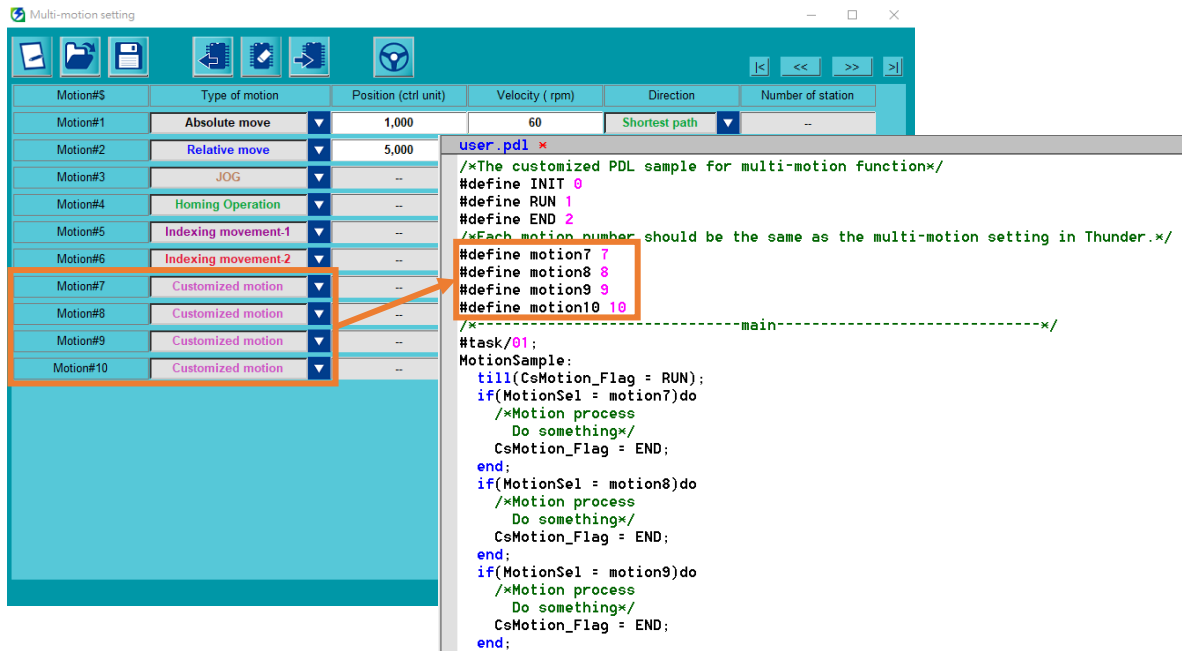

Figure 3.6.1 The motion number corresponding to customized motion

3. Edit motion process based on the requirement.

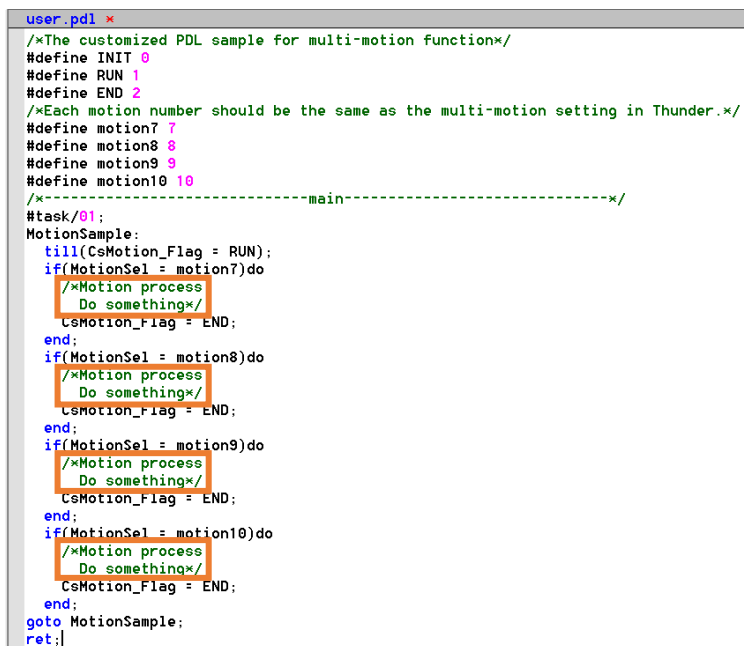

Figure 3.6.2 Edit motion process of customized motion

4. Refer to section 9.5.3 **Compile and save PDL** in “E Series Servo Drive Thunder Software Operation Manual” to compile and save PDL. After that, customized motion can be used.

3.7 Application setting: infinite rotation function

When multi-turn absolute AC servo motor rotates in a single direction for a long time by exceeding the countable limit of the encoder revolution, the rotation number will overflow, and the previous absolute position will not be maintained after servo drive is power cycled. Refer to section 8.17 **Infinite rotation function setting** in “E1 Series Servo Drive User Manual” and section 8.17 **Infinite rotation function setting** in “E2 Series Servo Drive User Manual” to set Pt205 - Upper limit of motor rotation number, which prevents the influence of encoder rotation number overflow and keeps the correct absolute position after servo drive is power cycled. This application is mainly for the rotary mechanism infinitely rotating in a single direction, such as indexing plate and turntable.



Important

- (1) Pt205 is only applicable to multi-turn absolute encoder with rotary mechanism, not with linear mechanism.
- (2) Complete the setting of Pt205 once before activating the motion.

Setting example – Rotary mechanism with reduction ratio of 3:7

1. Refer to chapter 2. In Thunder’s “Electronic gear ratio setting” window, select **Round table** for mechanical structure and set reduction ratio as 3:7. (Control unit is based on the requirement.)
2. Set Pt205 = 7.
3. Execute absolute encoder initialization.
4. Save the parameters and power cycle servo drive.

Reduction ratio
= Load side gear : Motor shaft gear = 3 rev : 7 rev

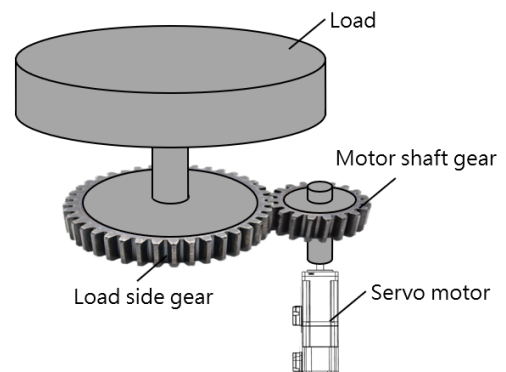

⚠ CAUTION

- ◆ When multi-turn absolute AC servo motor with rotary mechanism is used with multi-motion function, if Pt205 is not set, after it rotates in a single direction for a long time, the absolute position may be lost after servo drive is power cycled, which leads multi-motion function to move the motor to the wrong position.

3.8 Advanced setting

■ Automatic enabling function after power-on

After multi-motion function is activated, to make the servo drive be automatically enabled after power-on, users can set Pt662.□□1□ to use the automatic enabling function after power-on.

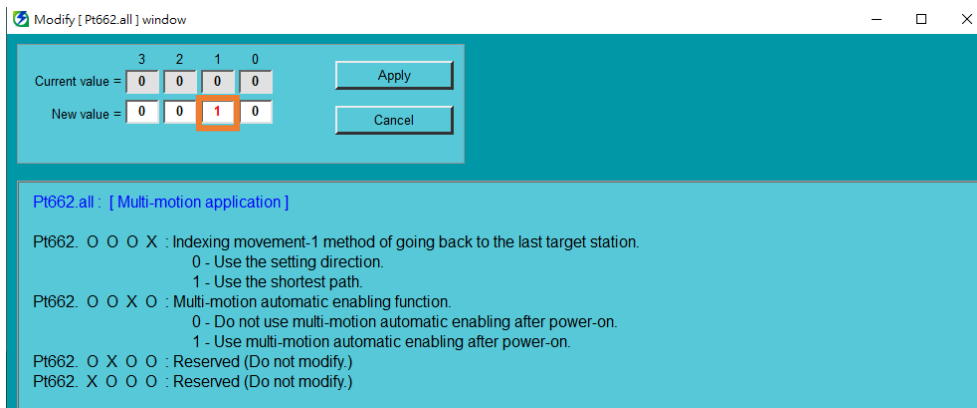

Figure 3.8.1 Use multi-motion automatic enabling function after power-on

⚠ CAUTION

- ◆ After this function is used, users cannot enable/disable servo drive by inputting S-ON in I/O. Instead, users should configure the motions “Software enable” and “Software disable” to enable/disable servo drive.
- ◆ After this function is used and the servo drive is power cycled and enabled, if users need to modify multi-motion setting, keep the status of servo drive as disabled.
- ◆ If users cannot disable servo drive via I/O, with Thunder software open, press shortcut key **F12** to perform emergency stop to temporarily disable servo drive.

■ Set the debounce time of Signal_Act signal

After multi-motion function is activated, if there is a risk that Signal_Act signal may be falsely triggered by noise, users can set Pt664 to extend the debounce time of Signal_Act signal to reduce the risk.

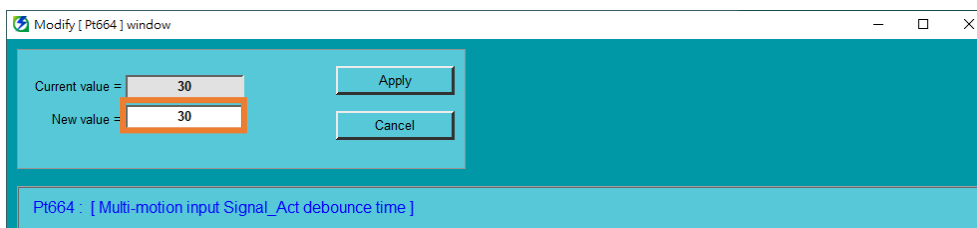

Figure 3.8.2 Set the debounce time of Signal_Act signal

■ **Overtravel alarm selection**

With Pt663.□□□X, users can select whether to output multi-motion alarm (AL.EF9) if overtravel is triggered during the execution of the motion.

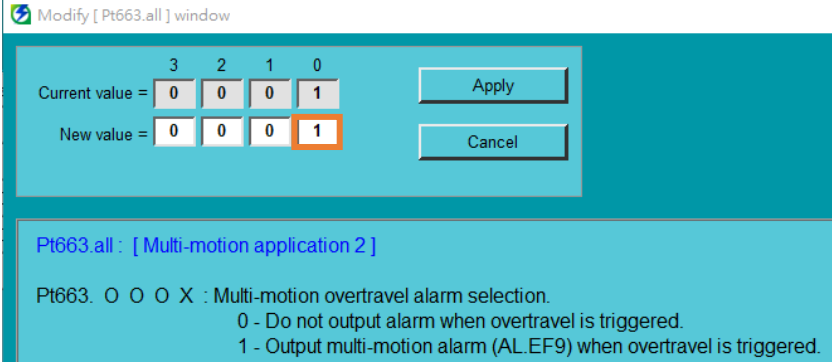



Figure 3.8.3 Set overtravel alarm selection

(This page is intentionally left blank.)

4. Save/Load multi-motion parameters file

4.	Save/Load multi-motion parameters file	4-1
4.1	Read multi-motion parameters from servo drive	4-2
4.2	Save/Load multi-motion parameters file (*.mtk)	4-2

4.1 Read multi-motion parameters from servo drive

If the multi-motion parameters are already saved in servo drive, users can click “Read from drive” icon  to read and display them. Users can modify motion number, the configuration of input pins, type of motion and other motion parameters before saving them to servo drive again.

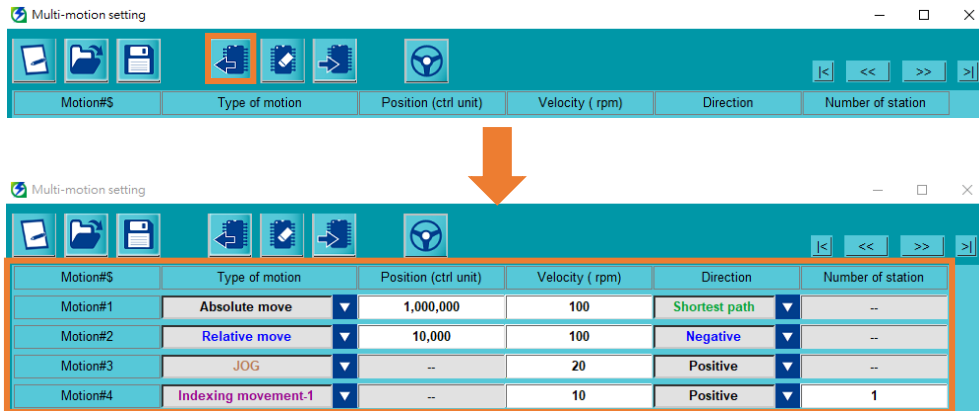



Figure 4.1.1 Read multi-motion parameters

4.2 Save/Load multi-motion parameters file (*.mtk)

To save the set multi-motion parameters as multi-motion parameters file (*.mtk), click “Save as a file” icon , key in file name of multi-motion parameters file (*.mtk), select archive path, and click **Save**.

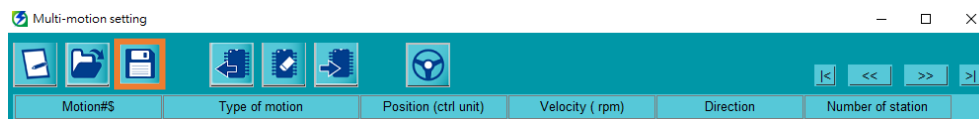



Figure 4.2.1 Save multi-motion parameters file

To load multi-motion parameters and display them on “Multi-motion setting” window, click “Load from file” icon , select multi-motion parameters file (*.mtk), and click **Open**.

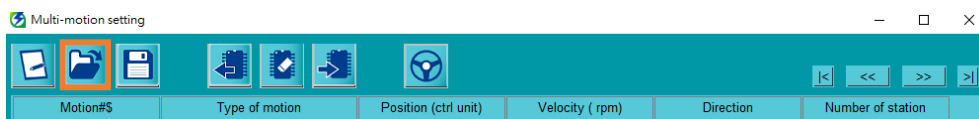

Figure 4.2.2 Load multi-motion parameters file

5. Test run

5.	Test run.....	5-1
5.1	Test run for multi-motion	5-2
5.2	Monitor load position.....	5-5

5.1 Test run for multi-motion

After completing the setting of multi-motion parameters, users can open “Test run for multi-motion” window to test the motion and ensure the configuration of digital input pins.



Information

- (1) “Test run for multi-motion” window may be different in different Thunder version.
- (2) Before test run for multi-motion, complete servo drive configuration first and ensure servo drive’s status is at “Servo ready” state. Refer to section 7.4 **Inspection before trial operation** in “E1 Series Servo Drive User Manual” and section 7.4 **Inspection before trial operation** in “E2 Series Servo Drive User Manual” for the related inspections. As for troubleshooting, refer to section 13.4 **Causes and corrective actions for abnormal operation** in “E1 Series Servo Drive User Manual” and section 13.4 **Causes and corrective actions for abnormal operation** in “E2 Series Servo Drive User Manual”.
- (3) For some servo motors, phase initialization must be done before test run. Refer to section 4.6 in “E Series Servo Drive Thunder Software Operation Manual” for details.

Follow the procedure below to perform test run for multi-motion. Here takes Motion#1 as an example.



- 1. Click “Send to drive” icon  to save the set multi-motion parameters to servo drive and activate multi-motion function.



Figure 5.1.1 Save the parameters to servo drive

- 2. Click “Test Run” icon  to open “Test run for multi-motion” window.

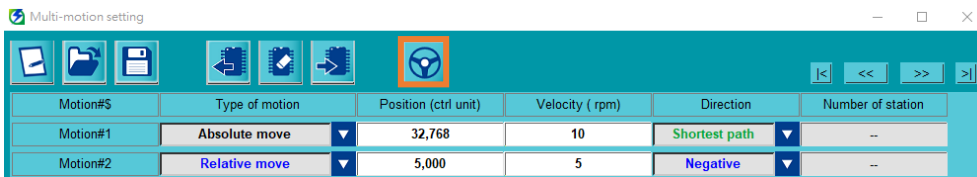



Figure 5.1.2 Open “Test run for multi-motion” window

- Users cannot modify the configuration of digital input pins displayed in this window, since it is based on the data saved in the servo drive. To modify the configuration, close this window and click “New or Modify” icon  to open “Set motion number and specify input signal” window. After the modification, send the setting to drive.

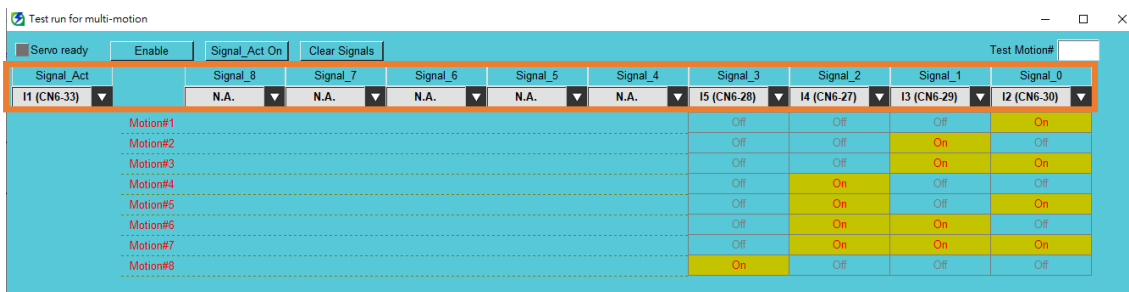

Figure 5.1.3 “Test run for multi-motion” window

- Click **Enable** and ensure the light of “Servo ready” lights up.

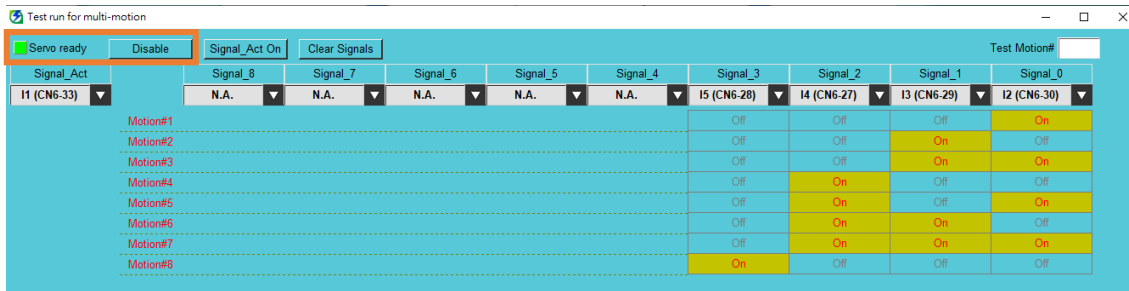

Figure 5.1.4 Enable the motor

- Key in **1** in **Test Motion#** column to trigger the corresponding digital input signals in simulated conditions.

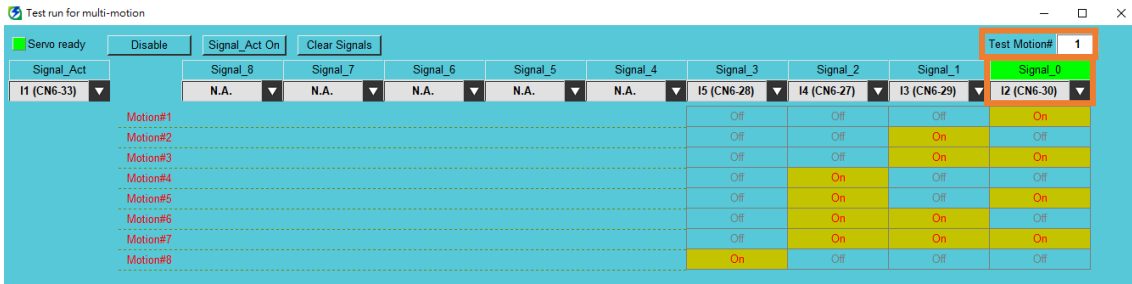

Figure 5.1.5 Trigger the corresponding digital input signals in simulated conditions

- Click **Signal_Act On** to trigger the digital input signal corresponding to Signal_Act in simulated conditions. At this time, servo drive will perform the motion of Motion#1.

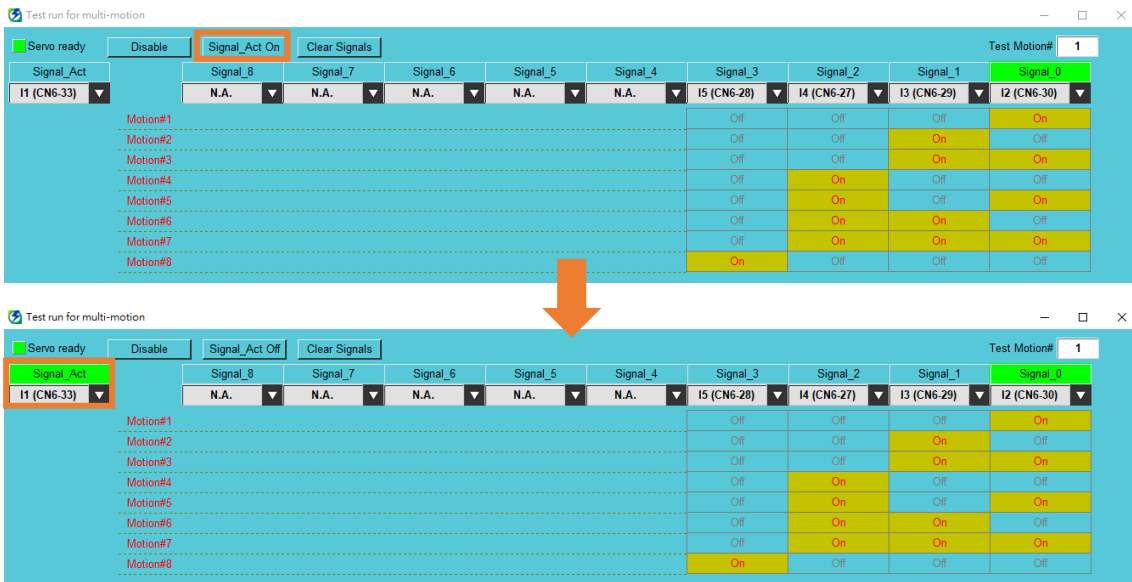

Figure 5.1.6 Trigger the digital input signal corresponding to Signal_Act in simulated conditions

- When the motion is done, click **Signal_Act Off** to clear Signal_Act signal, click **Clear Signals** to clear Signal_0~8 signals, and click **Disable**.
- The servo drive will be automatically power cycled after users close “Test run for multi-motion” window.

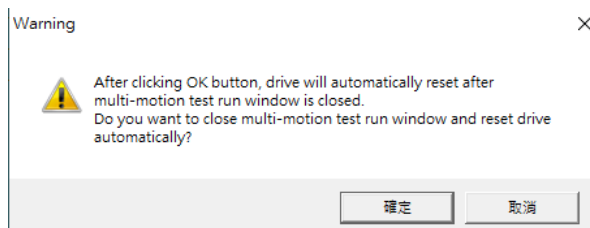



Figure 5.1.7 Check window of automatically power cycling servo drive

5.2 Monitor load position

To monitor load position after activating multi-motion function, open Thunder’s “Scope” window  and select physical quantity 26 - Load side single-turn position (multi-motion only).



Important

For physical quantity 26 - Load side single-turn position (multi-motion only), note the following points:

- (1) It has different meanings for rotary mechanism and linear mechanism.
 - Rotary mechanism: Display the current single-turn position of load; the values will not exceed one revolution of load side, and they are always positive.
 - Linear mechanism: Display the current position of load relative to home position; the values can be positive or negative.
- (2) It supports electronic gear ratio and display unit switching.

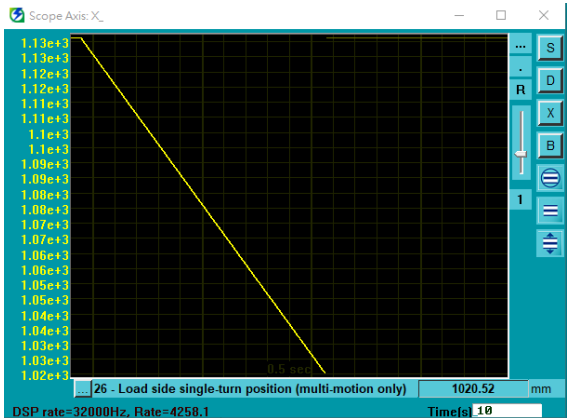
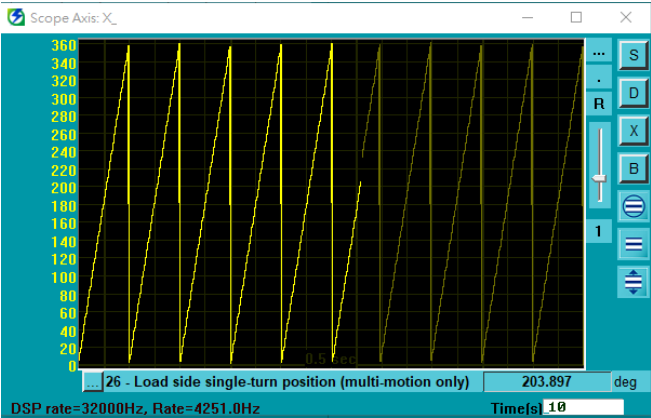

Figure 5.2.1 Load side single-turn position: rotary mechanism (left), linear mechanism (right)

(This page is intentionally left blank.)

6. Related warning and alarm

6. Related warning and alarm	6-1
------------------------------------	-----

When multi-motion related warning AL947 or alarm ALEF9 occurs, multi-motion function may become invalid. If multi-motion function is invalid, in the bottom-left corner of Thunder main window, the light of “Multi-motion activated” will be gray. With the following steps and Table 6.1 or Table 6.2, users can check if multi-motion function is invalid when the warning or the alarm occurs, the cause and the troubleshooting method.

1. Ensure warning AL947 or alarm ALEF9 occurs.

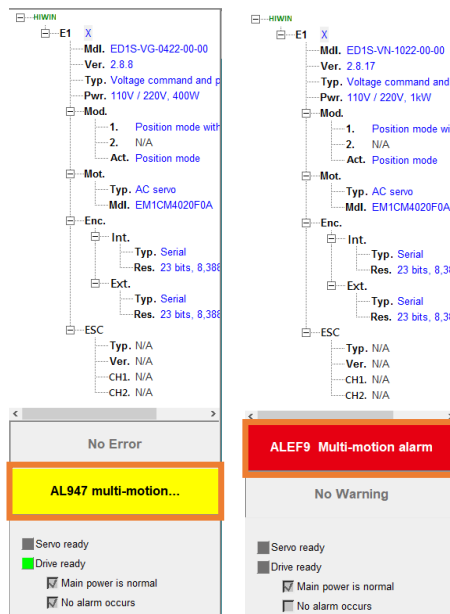

Figure 6.1 Warning AL947 or alarm ALEF9 pops up

2. Open Thunder’s “Messages + command prompt” window to check the messages shown in the window.

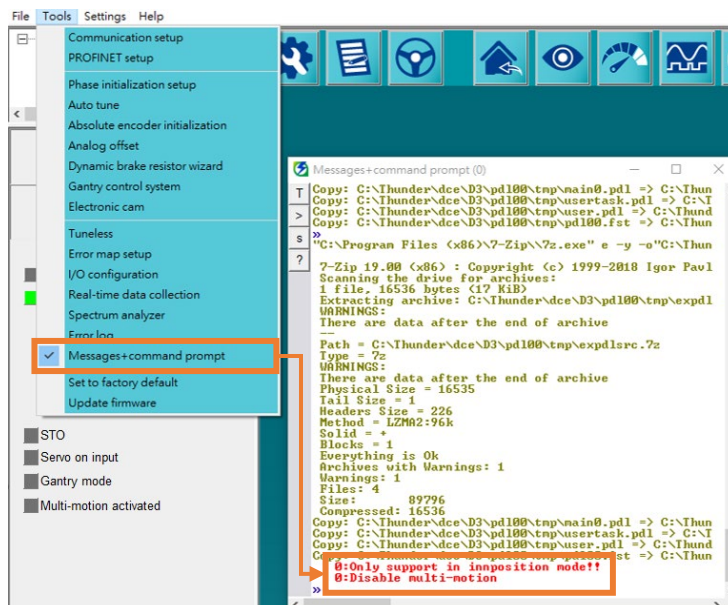

Figure 6.2 Check warning or alarm messages

Table 6.1 Multi-motion related warning messages - AL947

Warning Message	Cause	Corrective Action
Only support in internal position mode	The control mode setting is wrong.	Change control mode to internal position mode, save it to servo drive and power cycle servo drive.
Fieldbus servo drive mastership error	The mastership of Fieldbus servo drive is Controller.	Set Pt010.□□□0, save it to servo drive and power cycle servo drive.
Ctrl unit of one revolution is overflow	The control unit (ctrl unit) value setting of load side's one revolution exceeds 2^{31} .	Go to "Electronic gear ratio setting" window in Thunder's Configuration Wizard to change the setting, make the control unit value of load side's one revolution less than 2^{31} , save it to servo drive and power cycle servo drive.
Homing process failed	The servo drive fails to execute the homing with multi-motion function.	Refer to section 8.11 Internal homing in "E1 Series Servo Drive User Manual" and section 8.11 Internal homing in "E2 Series Servo Drive User Manual" for troubleshooting.
Homing offset failed	The servo drive fails to execute the motion "Zero Point Position Offset in Machine Coordinate System".	<p>(1) The servo drive cannot be automatically disabled. After manually disabling servo drive, execute Zero Point Position Offset in Machine Coordinate System again.</p> <p>(2) If absolute encoder is used and the servo drive fails to execute homing method -3, refer to section 8.11 Internal homing in "E1 Series Servo Drive User Manual" and section 8.11 Internal homing in "E2 Series Servo Drive User Manual" for troubleshooting.</p>
Please enable first	The motion is executed when the servo drive is disabled.	Enable the servo drive before executing the motion.
Please homing first	The motion is executed when the homing is not completed with multi-	Complete homing with multi-motion function before executing the motion.

Warning Message	Cause	Corrective Action
	motion function.	
Not support the mechanical structure	The mechanism type cannot execute the motion.	Refer to section 3.3 to select the motor and the mechanism suitable for the motion.
Not support LM	Linear motor cannot execute the motion.	Refer to section 3.3 to select the motor and the mechanism suitable for the motion.

Table 6.2 Multi-motion related alarm messages - ALEF9

Alarm Message	Cause	Corrective Action
Multi-motion overtravel error	Overtravel is triggered during the execution of the motion.	Check if the travel distance of the motion exceeds the overtravel position. Adjust the travel distance of the motion to avoid triggering overtravel.

7. Appendix

7.	Appendix	7-1
7.1	Release note for multi-motion function	7-2
7.2	Old version's related warning	7-5

7.1 Release note for multi-motion function

The following table shows the functions added/supported and setting limits of multi-motion function in each Thunder version.

Table 7.1.1 Release note for multi-motion function

Thunder Version	Function added/supported	Setting Limit
1.4.8.1	<ol style="list-style-type: none"> Support standard voltage command and pulse model (model: ED1S-V□) and Fieldbus megalink model (model: ED1F-H□). Support direct drive motor (DM) and torque motor (TM). Both standard servo drive and Fieldbus servo drive support 64 motions. Support type of motion: Absolute move, Relative move, Indexing movement, JOG, Homing Operation. 	<ol style="list-style-type: none"> When standard servo drive is used, save an input pin to configure S-ON. The homing method of absolute direct drive/torque motor is always finding index signal with the shortest path. When the multi-motion parameters are saved to servo drive, electronic gear ratio will be changed to 1:1.
1.6.11.0	<ol style="list-style-type: none"> Add type of motion: Customized motion. 	<ol style="list-style-type: none"> When standard servo drive is used, save an input pin to configure S-ON. The homing method of absolute direct drive/torque motor is always finding index signal with the shortest path. When the multi-motion parameters are saved to servo drive, electronic gear ratio will be changed to 1:1.
1.6.19.0	<ol style="list-style-type: none"> Support linear motor (LM). 	<ol style="list-style-type: none"> When standard servo drive is used, save an input pin to configure S-ON. The homing method of absolute direct drive/torque motor is always finding index signal with the shortest path.

Thunder Version	Function added/supported	Setting Limit
		<ol style="list-style-type: none"> When the multi-motion parameters are saved to servo drive, electronic gear ratio will be changed to 1:1.
1.7.17.0	<ol style="list-style-type: none"> Support AC servo motor (AC). Support AC servo motor used with rotary/linear mechanism with reduction ratio of 1:250 or below. Support electronic gear ratio. Add “Test run for multi-motion” window. Add monitoring physical quantity 26 - Load side single-turn position (multi-motion only). 	<ol style="list-style-type: none"> When standard servo drive is used, save an input pin to configure S-ON. The homing method of absolute direct drive/torque motor is always finding index signal with the shortest path.
1.8.8.0	<ol style="list-style-type: none"> Support Fieldbus EtherCAT model (model: ED1F-E□), Fieldbus MECHATROLINK-III model (model: ED1F-L□) and Fieldbus PROFINET model (model: ED1F-P□). Support AC servo motor used with rotary/linear mechanism with reduction ratio of 1:5000 or below. Standard servo drive supports 255 motions; Fieldbus servo drive supports 127 motions. Add type of motion: Software enable, Software disable, Clear error, Zero Point Position Offset in Machine Coordinate System. The bottom-left corner of Thunder main window adds the light of “Multi-motion activated”. It will light up when multi-motion function is activated; it will be gray when multi-motion function is disabled/invalid. Support Pt662.□□□X - Indexing movement-1 method of going back to the last target station, Pt662.□□X□ - Multi-motion automatic enabling function and Pt664 - Multi-motion input Signal_Act debounce time. Thunder adds Pt205, which can used with multi-motion function. Fieldbus mega-ulink model used with multi- 	<ol style="list-style-type: none"> When host controller is used, Fieldbus servo drive does not support multi-motion function. When the multi-motion parameters are saved to servo drive, the mastership will be set as Pt010.□□□0. Fieldbus MECHATROLINK-III model only supports electronic gear ratio as 1:1. When Fieldbus servo drive is used, configure the motions “Software enable” and “Software disable”.

Thunder Version	Function added/supported	Setting Limit
	motion function supports electronic gear ratio.	
1.9.18.0	<ol style="list-style-type: none"> 1. Support Pt663.□□□X - Multi-motion overtravel alarm selection. 2. Add alarm ALEF9 - Multi-motion alarm. 	<ol style="list-style-type: none"> 1. When host controller is used, Fieldbus servo drive does not support multi-motion function. When the multi-motion parameters are saved to servo drive, the mastership will be set as Pt010.□□□0. 2. When Fieldbus servo drive is used, configure the motions "Software enable" and "Software disable".

7.2 Old version's related warning

If warning AL947 appears when old Thunder version is used, refer to chapter 6 to check warning messages, and do troubleshooting according to the following table.

Table 7.2.2 Old version's multi-motion related warning messages

Warning Message	Cause	Corrective Action
AC need higher firmware version	The current Thunder version does not support AC servo motor.	Update Thunder version to 1.7.17.0 or above.
Not support AC motor		
Electronic gear ratio must be 1	The electronic gear ratio (Pt20E, Pt210) setting is wrong.	Change electronic gear ratio (Pt20E, Pt210) to 1:1, save it to servo drive and power cycle servo drive.
Only support in internal position mode	The control mode setting is wrong.	Change control mode to internal position mode, save it to servo drive and power cycle servo drive.
Reduction ratio is too big	The reduction ratio setting exceeds 1:250.	Use the reducer with reduction ratio of 1:250 or below and change the setting of "Electronic gear ratio setting" window.
Encoder is closed to overflow	The motor keeps moving more than 32000 revolutions when multi-turn absolute AC servo motor is used with rotary mechanism.	The servo drive will stop the motor, automatically disable the motor, and re-enable the motor. After the servo drive re-enables the motor, activate the motion again.
Movement is too big	The motion moves more than 256 revolutions of motor at a time when multi-turn absolute AC servo motor is used.	Reduce the moving distance of motion.
EEPROM write error	The servo drive malfunctions.	Replace the servo drive.
Multi-turn Data clear fail	The servo drive fails to reset multi-motion data when multi-turn absolute AC servo motor is used.	The AC servo motor or the servo drive may malfunction. Replace the AC servo motor or the servo drive.
Homing process failed	The servo drive fails to execute the homing with multi-motion function.	Refer to section 8.11 Internal homing in "E1 Series Servo Drive User Manual" for troubleshooting.
Please homing first	The motion is executed when the	Complete homing with multi-motion

Warning Message	Cause	Corrective Action
	homing is not completed with multi-motion function.	function before executing the motion.
Not support LM	Linear motor cannot execute the motion.	Refer to section 3.3 to select the motor and the mechanism suitable for the motion.
Time Out	The executed motion is not completed in 30 seconds (except for JOG).	(1) Check if the motor cannot move due to the disabled status or the pop-up alarm. (2) Ensure the setting value of Pt522 is appropriate to avoid not completing the positioning (COIN).